

Corn Sheller

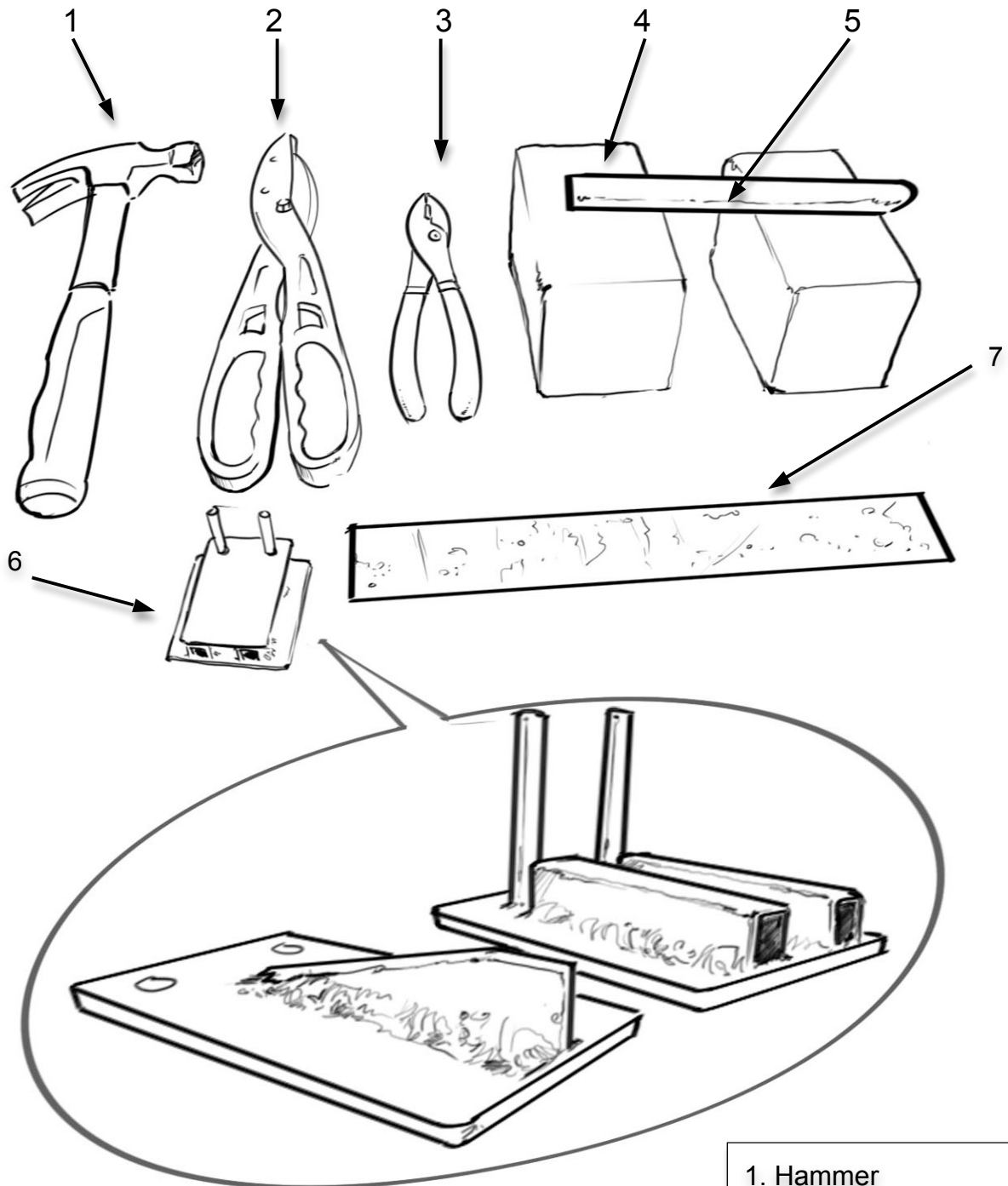

This simple hand tool makes it possible to shell maize (corn) several times faster than by hand. Maize shellers can be made in many ways using a variety of materials. This instructional manual shows how to make a maize sheller out of sheet metal using a simple jig.

1. Tools



- 1. Hammer
- 2. Shears
- 3. Pliers
- 4. Wood Block
- 5. Pipe or Rod
- 6. Jig
- 7. Sheet Metal

2. Measuring & Marking

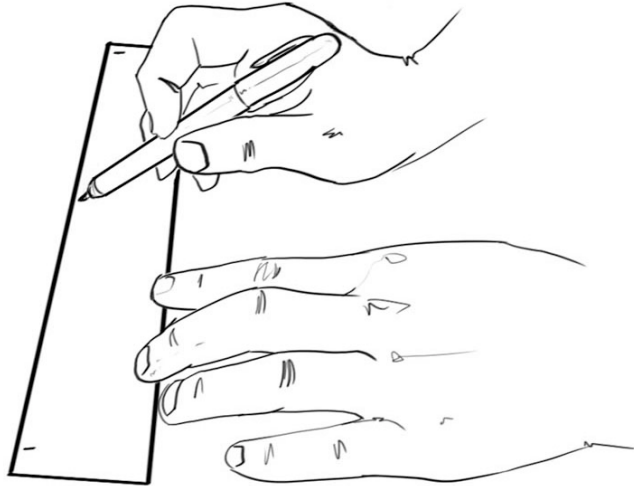
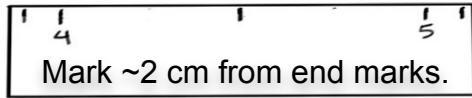
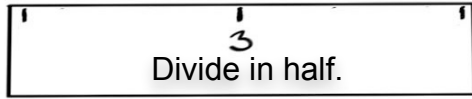
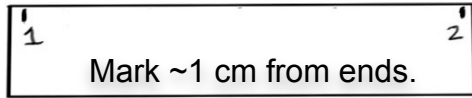

3. Bending the Tabs

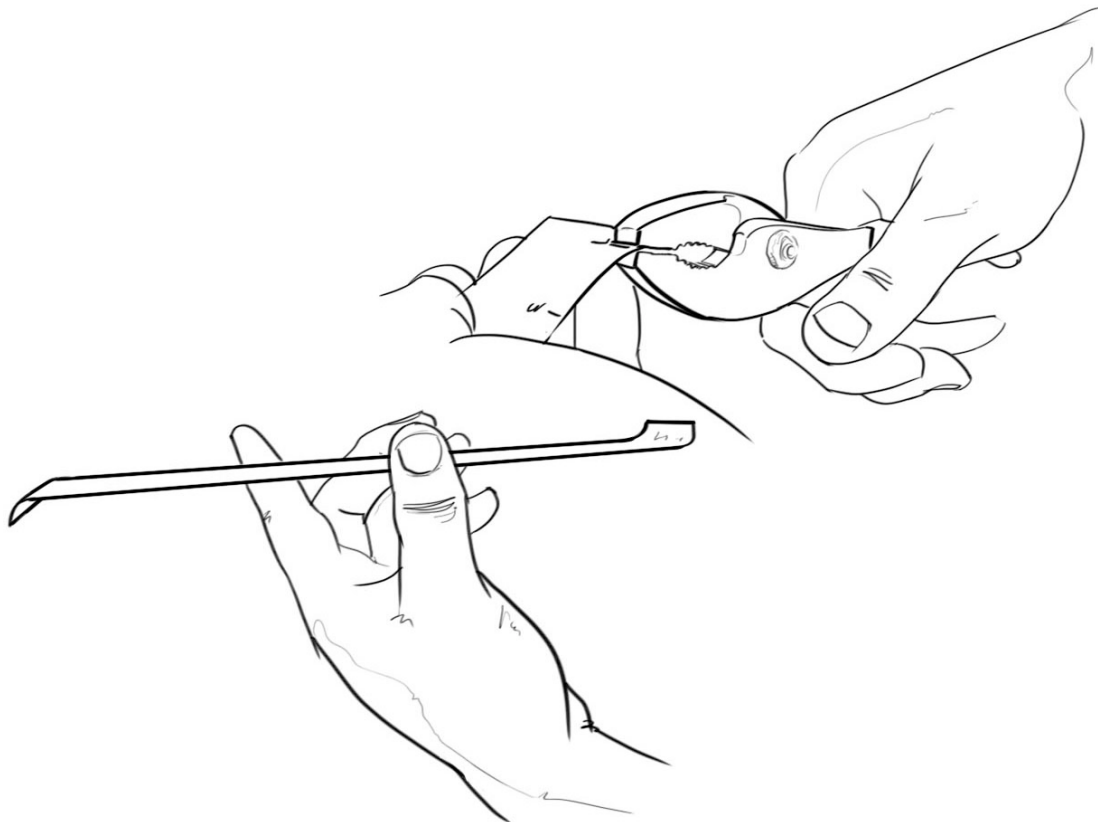

4. Forming the Ridges

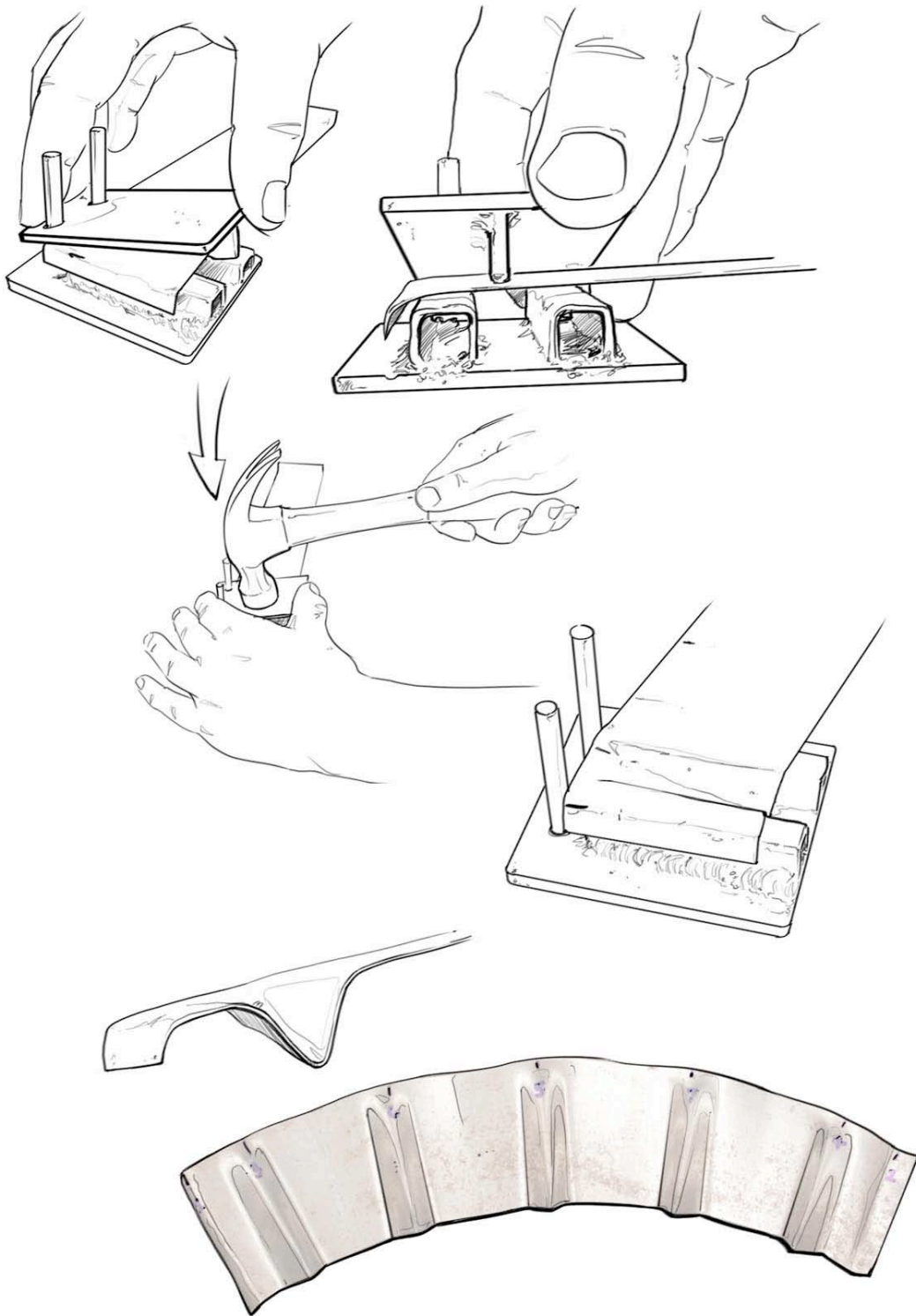

5. Shaping



7. Crimping the Ends

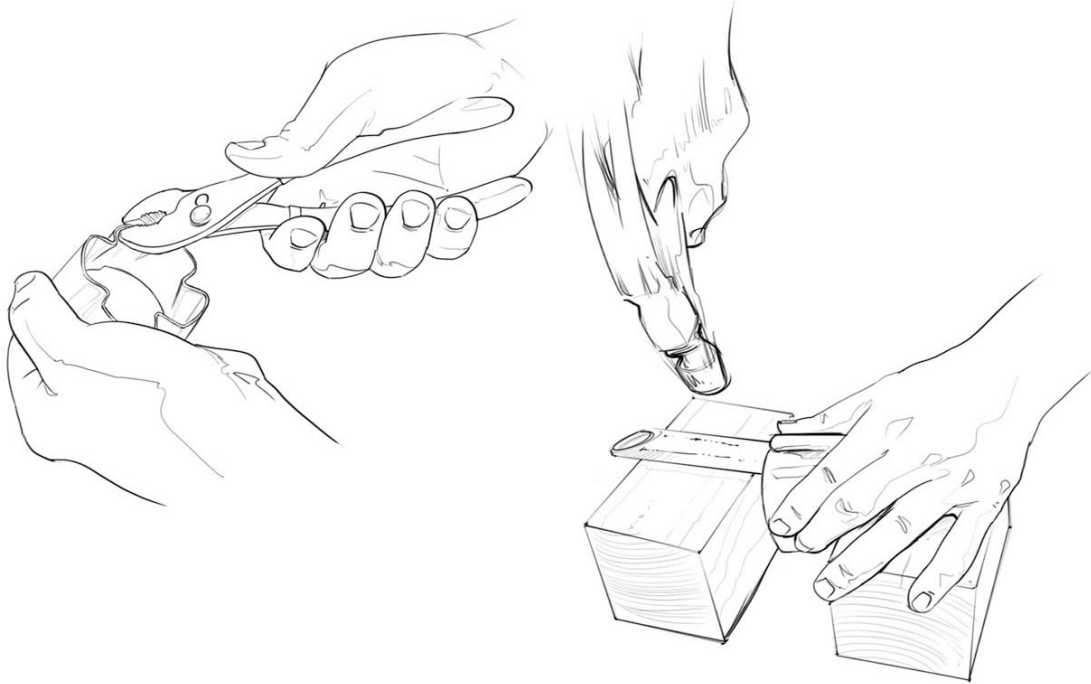

8. Finished Product



Documentation by *D-Lab* at MIT

Sponsored by  NCIIA

Contact Info

d-lab@mit.edu
(617) 253 5985

These materials are provided under the Attribution-Non-Commercial 3.0 Creative Commons License, <http://creativecommons.org/licenses/by-nc/3.0/>. If you choose to reuse or repost the materials, you must give proper attribution to MIT, and you must include a copy of the non-commercial Creative Commons license, or a reasonable link to its url with every copy of the MIT materials or the derivative work you create from it.



Please use the following citation format: *D-Lab Corn Sheller Do-It* Copyright © Massachusetts Institute of Technology (Accessed on [insert date]).